

083319 | FIRA

UNDERMOUNT WITH APRON FRONT FIRECLAY KITCHEN SINK

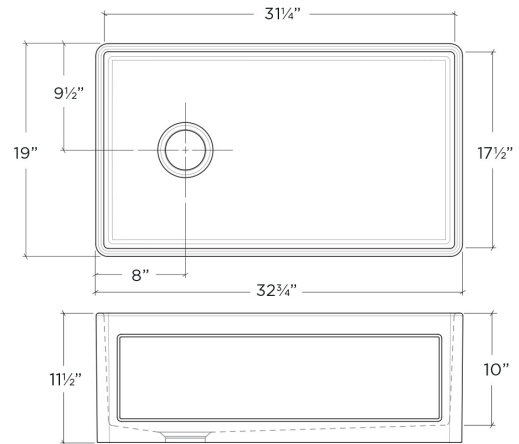

Specifications

Model	083319
Collection	Fira
Bowl dimensions	31 1/4" × 17 1/2" × 10"
Overall dimensions	32 3/4" × 19" × 11 1/2"
Recommended cabinet	36"

Recommended accessories

Drain	100080
Grid	200264
Grid (coming soon)	200938

Warranty

Home Refinements offers a 1-YEAR LIMITED WARRANTY against manufacturing defects and a 10-YEAR LIMITED WARRANTY on fading/staining issues on its fireclay sinks. For further details on our product warranty, please refer to our catalog or Web site.

Features

- Designed in Canada, handcrafted in Italy
- Reversible apron front design: flat or shaker style
- Deep 10" bowl and 3/4" thick walls for optimized work space
- Product dimensional variability $\pm 3/16"$, due to manufacturing process
- Made of fireclay and glazed on all sides, white gloss finish
- Offset center 3-1/2" drain
- Sloped bottom for maximized drainage
- Waste disposal unit compatible, recommended to confirm waste disposal or drain maximal thickness specifications
- No template provided, recommended to have the sink on hand for final sizing of cabinet and countertop
- ASME A112.19.2/CSA B45.1